

MPS 025 COMPLETE

# MPS 025/1

For handling and gripping applications

R

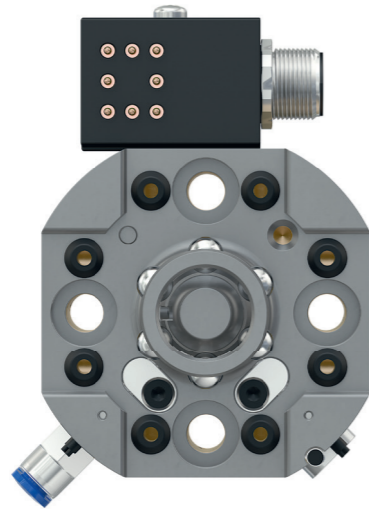

T

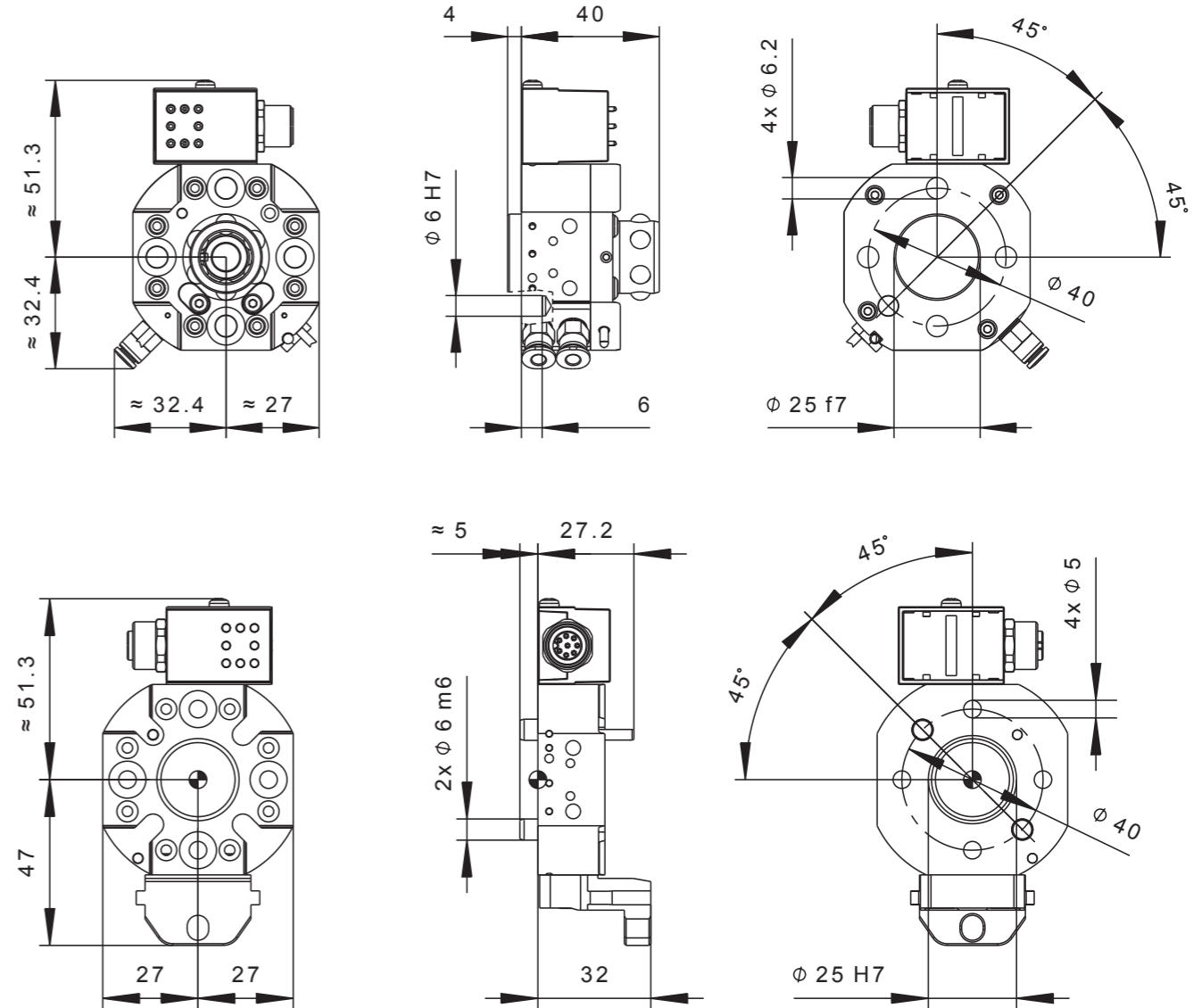
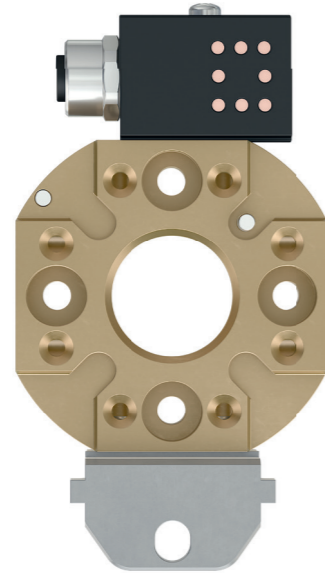

	Order no.	Unlock/ lock port	Pneumatic pass-through		Data and signal transfer		Sensors/ connection
			Quantity	Size	Connection	Pole	
R	MPS025RO-0000-6A8C-0000-D1S0	2x Push-lock hose-Ø 4 mm	4	M5	M12	8	-
	MPS025RC-0000-6A8C-0000-D1S0						3x PNP/ 3x M8
	MPS025RG-0000-6A8C-0000-D1S0						3x NPN/ 3x M8
T	MPS025TO-0000-6A8C-0000-D1S0	-	4	M5	M12	8	-

Technical data for the base unit on the robot and tool sides can be found on page 19.  
 Technical data for all transfer modules can be found from page 34 onwards.  
 Transmission modules with other threaded and plug-in connections can be individually adapted at any time via our simple configuration system  
 (see page 16) to suit your individual requirements.